

UMI CS/3405

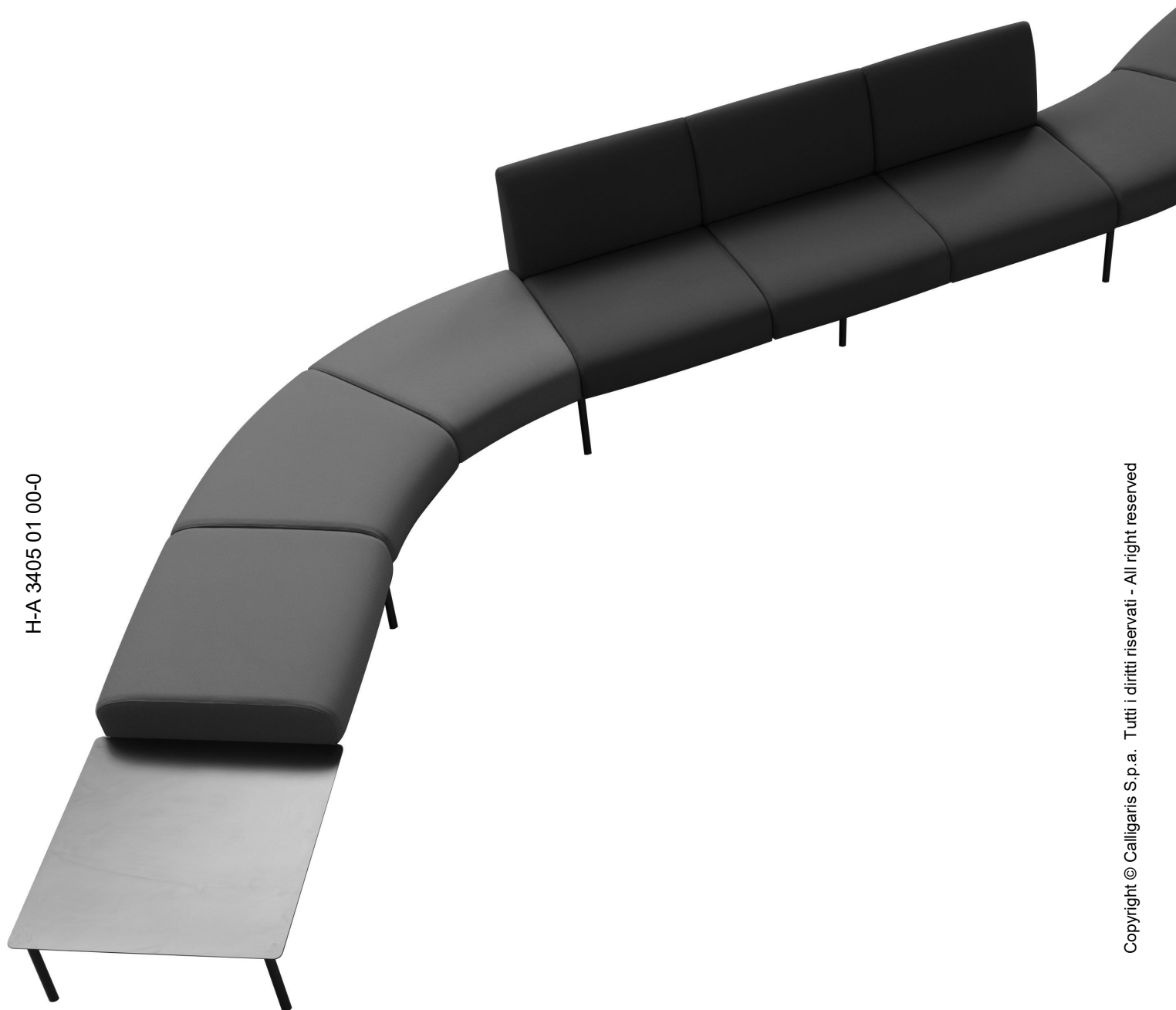

H-A 3405 01 00-0

Copyright © Calligaris S.p.a. Tutti i diritti riservati - All right reserved

Manuale d'uso



Calligaris S.p.a.
Via Trieste, 12
33044 Manzano
(Udine) Italy
Tel. +39 0432 748211
Fax +39 0432 750104

Elementi disponibili base

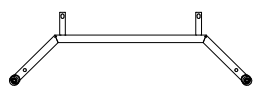

Fianco (A)

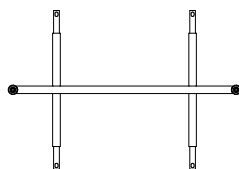

Collegamento (B)

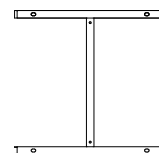

1 Posto (C)

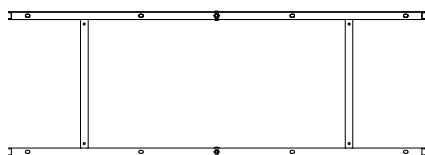

2 Posti (D)

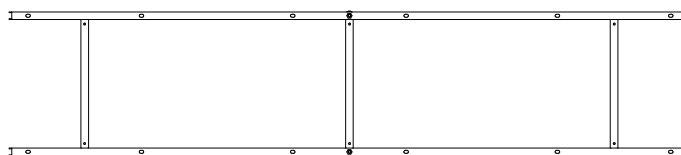

3 Posti (E)

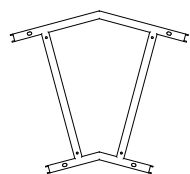

Curva Singola (F)

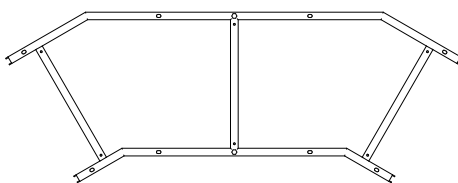

Curva Doppia (G)



Piede (H)

Elementi disponibili sedute/piano

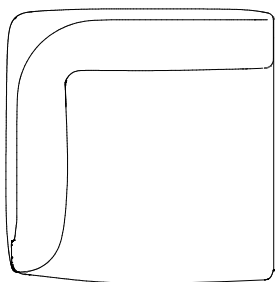

Seduta
Bracciolo SX (L)

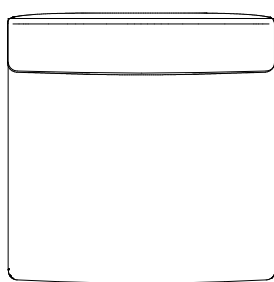

Seduta con
Schienale (M)

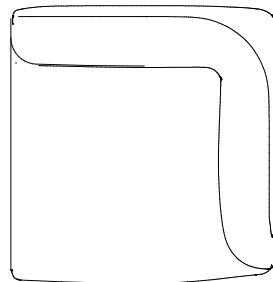

Seduta
Bracciolo DX (N)

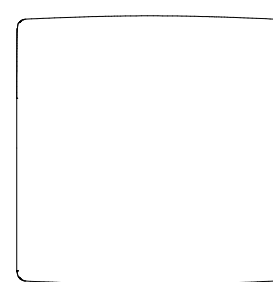

Pouf (P)

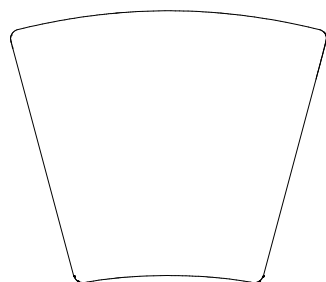

Seduta per
Curva (Q)

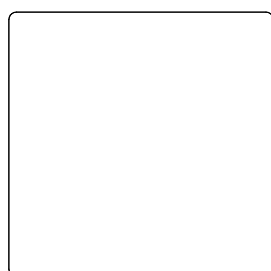

Tavolino (R)

Esempi di composizione

misure in cm



- Fianco (A) 2pz.
- 1 Posto (C) 1pz.
- Pouf (P) 1pz.

Pouf
70 x 70 x Hs 42



- Fianco (A) 2pz.
- 1 Posto (C) 1pz.
- Seduta con Schienale (M) 1pz.

Seduta con schienale
70 x 70 x Hs 42



- Fianco (A) 2pz.
- 2 Posti (D) 1pz.
- Piede (H) 2pz.
- Seduta Bracciolo SX (L) 1pz.
- Seduta Bracciolo DX (N) 1pz.

Due posti con braccioli
140 x 70 x Hs 42



- Fianco (A) 2pz.
- 2 Posti (D) 1pz.
- Piede (H) 2pz.
- Seduta con Schienale (M) 2pz.

Due posti con schienale
140 x 70 x Hs 42



Due posti con schienale e pouf
140 x 70 x Hs 42

- Fianco (A) 2pz.
- 2 Posti (D) 1pz.
- Piede (H) 2pz.
- Seduta con Schienale (M) 1pz.
- Pouf (P) 1pz.



Due posti con pouf
140 x 70 x Hs 42

- Fianco (A) 2pz.
- 2 Posti (D) 1pz.
- Piede (H) 2pz.
- Pouf (P) 2pz.



Due posti con bracciolo e pouf
140 x 70 x Hs 42

- Fianco (A) 2pz.
- 2 Posti (D) 1pz.
- Piede (H) 2pz.
- Seduta Bracciolo SX (L) 1pz.
- Pouf (P) 1pz.



Tre posti con braccioli e con schienale
210 x 70 x Hs 42

- Fianco (A) 2pz.
- 3 Posti (E) 1pz.
- Piede (H) 2pz.
- Seduta Bracciolo SX (L) 1pz.
- Seduta con Schienale (M) 1pz.
- Seduta con Bracciolo DX (N) 1pz.



Tre posti con schienali
210 x 70 x Hs 42

- Fianco (A) 2pz.
- 3 Posti (E) 1pz.
- Piede (H) 2pz.
- Seduta con Schienale (M) 3pz.



Tre posti con bracciolo, con schienale e
tavolino
210 x 70 x Hs 42

- Fianco (A) 2pz.
- 3 Posti (E) 1pz.
- Piede (H) 2pz.
- Seduta Bracciolo SX (L) 1pz.
- Seduta con Schienale (M) 1pz.
- Tavolino (R) 1pz.



Tre posti con schienale e tavolino
210 x 70 x Hs 42

- Fianco (A) 2pz.
- 3 Posti (E) 1pz.
- Piede (H) 2pz.
- Seduta con Schienale (M) 2pz.
- Tavolino (R) 1pz.



Tre posti con schienale, con pouf e tavolino
210 x 70 x Hs 42

- Fianco (A) 2pz.
- 3 Posti (E) 1pz.
- Piede (H) 2pz.
- Seduta con Schienale (M) 1pz.
- Pouf (P) 1pz.
- Tavolino (R) 1pz.



- Fianco (A) 2pz.
- 3 Posti (E) 1pz.
- Piede (H) 2pz.
- Seduta con Schienale (M)2pz.
- Pouf (P) 1pz.

Tre posti con schienali e pouf
210 x 70 x Hs 42



- Fianco (A) 2pz.
- 3 Posti (E) 1pz.
- Piede (H) 2pz.
- Seduta con Schienale (M)1pz.
- Pouf (P) 2pz.

Tre posti con schienale e pouf
210 x 70 x Hs 42



- Fianco (A) 2pz.
- 3 Posti (E) 1pz.
- Piede (H) 2pz.
- Pouf (P) 3pz.

Tre posti con pouf
210 x 70 x Hs 42



- Fianco (A) 2pz.
- 2 Posti (D) 1pz.
- 3 Posti (E) 2pz.
- Curva Doppia (G) 1pz.
- Curva Singola (F) 1pz.
- Collegamento (B) 4pz.
- Piede (H) 8pz.
- Tavolino (R) 2pz.
- Pouf (P) 3pz.
- Seduta per curva (Q) 3pz.
- Seduta con schienale (M) 3pz.

Composizione a "S"
720 x 209 x Hs 42



- Collegamento (B) 6pz.
- Curva Doppia (G) 6pz.
- Piede (H) 12pz.
- Seduta per curva (Q) 12pz.

Composizione circolare
D 325 x Hs 42

UMI CS/3405



User manual

Copyright © Calligaris S.p.a. - Tutti i diritti riservati - All right reserved



Calligaris S.p.a.
Via Trieste, 12
33044 Manzano
(Udine) Italy
Tel. +39 0432 748211
Fax +39 0432 750104

Available frame elements



Side frame (A)

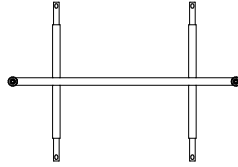

Link (B)

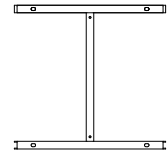

1 Unit (C)

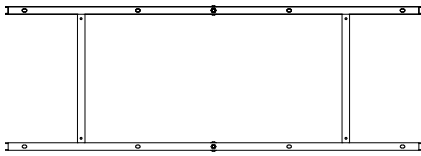

2 Units (D)

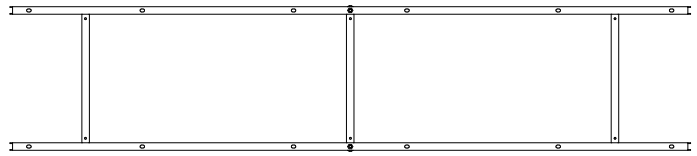

3 Units (E)

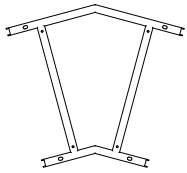

Single angular frame (F)

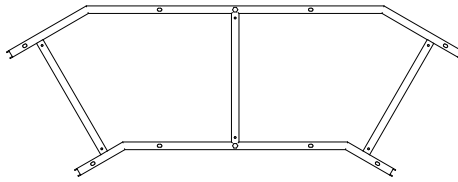

Double angular frame (G)



Foot (H)

Available seat and table elements

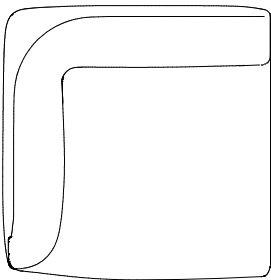

Seat with left armrest (L)

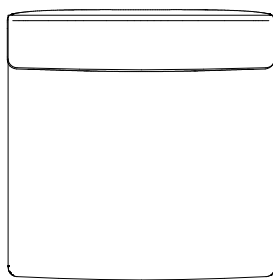

Seat with backrest (M)

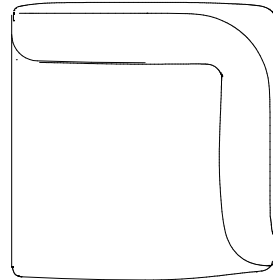

Seat with right armrest (N)

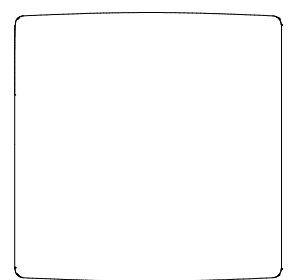

Ottoman (P)

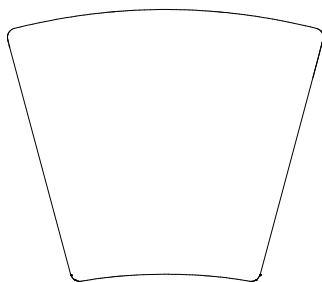

Angular seat element (Q)

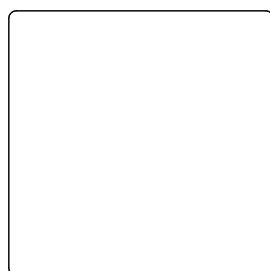

Table (R)

Layout examples

measures in cm



- Side frame (A) 2pz.
- 1 Unit (C) 1pz.
- Ottoman (P) 1pz.

Ottoman
70 x 70 x Sh 42



- Side frame (A) 2pz.
- 1 Unit (C) 1pz.
- Seat with backrest(M) 1pz.

Seat with backrest
70 x 70 x Sh 42



- Side frame (A) 2pz.
- 2 Units (D) 1pz.
- Foot (H) 2pz.
- Seat with left armrest(L) 1pz.
- Seat with right armrest(N) 1pz.

Two seater with armrest
140 x 70 x Sh 42



- Side frame (A) 2pz.
- 2 Units (D) 1pz.
- Foot (H) 2pz.
- Seat with backrest(M) 2pz.

Two seater with backrest
140 x 70 x Sh 42



Two seater with backrest and ottoman
140 x 70 x Sh 42

- Side frame (A) 2pz.
- 2 Units (D) 1pz.
- Foot (H) 2pz.
- Seat with backrest(M) 1pz.
- Ottoman (P) 1pz.



Two seater ottoman
140 x 70 x Sh 42

- Side frame (A) 2pz.
- 2 Units (D) 1pz.
- Foot (H) 2pz.
- Ottoman (P) 2pz.



Two seater with armrest and ottoman
140 x 70 x Sh 42

- Side frame (A) 2pz.
- 2 Units (D) 1pz.
- Foot (H) 2pz.
- Seat with left armrest(L) 1pz.
- Ottoman (P) 1pz.



Three seater with armrest and backrest
210 x 70 x Sh 42

- Side frame (A) 2pz.
- 3 Units (E) 1pz.
- Foot (H) 2pz.
- Seat with left armrest(L) 1pz.
- Seat with backrest(M) 1pz.
- Seat with right armrest(N) 1pz.



Three seater with backrest
210 x 70 x Sh 42

- Side frame (A) 2pz.
- 3 Units (E) 1pz.
- Foot (H) 2pz.
- Seat with backrest(M) 3pz.



Three seater with armrest, backrest and table
210 x 70 x Sh 42

- Side frame (A) 2pz.
- 3 Units (E) 1pz.
- Foot (H) 2pz.
- Seat with left armrest(L) 1pz.
- Seat with backrest(M) 1pz.
- Table (R) 1pz.



Three seater with backrest and table
210 x 70 x Sh 42

- Side frame (A) 2pz.
- 3 Units (E) 1pz.
- Foot (H) 2pz.
- Seat with backrest(M) 2pz.
- Table (R) 1pz.



Three seater with backrest, ottoman and
table
210 x 70 x Sh 42

- Side frame (A) 2pz.
- 3 Units (E) 1pz.
- Foot (H) 2pz.
- Seat with backrest (M)1pz.
- Ottoman (P) 1pz.
- Table (R) 1pz.



Three seater with backrest and ottoman
210 x 70 x Sh 42

- Side frame (A) 2pz.
- 3 Units (E) 1pz.
- Foot (H) 2pz.
- Seat with backrest (M)2pz.
- Ottoman (P) 1pz.



Three seater with backrest and ottoman
210 x 70 x Sh 42

- Side frame (A) 2pz.
- 3 Units (E) 1pz.
- Foot (H) 2pz.
- Seat with backrest (M)1pz.
- Ottoman (P) 2pz.

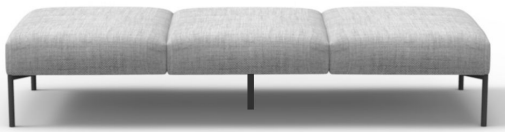

Three seater ottoman
210 x 70 x Sh 42

- Side frame (A) 2pz.
- 3 Units (E) 1pz.
- Foot (H) 2pz.
- Ottoman (P) 3pz.



- Side frame (A) 2pz.
- 2 Units (D) 1pz.
- 3 Units (E) 2pz.
- Double angular frame(G) 1pz.
- Single angular frame(F) 1pz.
- Link (B) 4pz.
- Foot (H) 8pz.
- Table (R) 2pz.
- Ottoman (P) 3pz.
- Angular seat element (Q) 3pz.
- Seat with backrest(M) 3pz.

"S" shape composition
720 x 209 x Sh 42



- Link (B) 6pz.
- Double angular frame(G) 6pz.
- Foot (H) 12pz.
- Angular seat element (Q) 12pz.

Round composition
D 325 x Sh 42

UMI CS/3405



Benutzerhandbuch

Copyright © Calligaris S.p.a. - Tutti i diritti riservati - All right reserved



Calligaris S.p.a.
Via Trieste, 12
33044 Manzano
(Udine) Italy
Tel. +39 0432 748211
Fax +39 0432 750104

Verfügbare Einheiten, Sockel

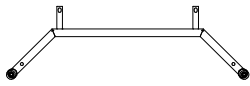

Seite (A)

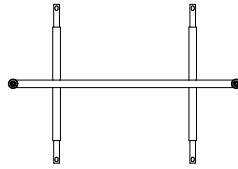

Verbindung (B)

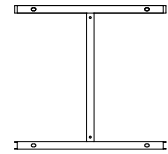

1 Platz (C)

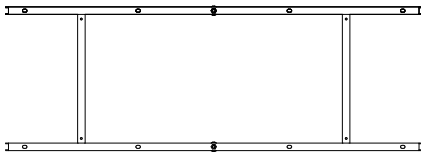

2 Plätze (D)

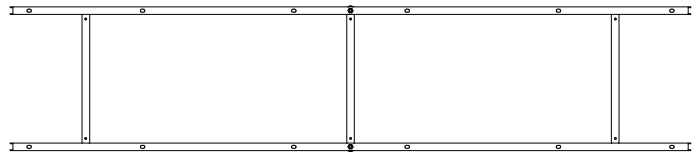

3 Plätze (E)

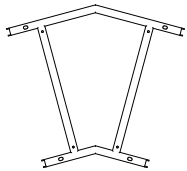

Einzelrundung (F)

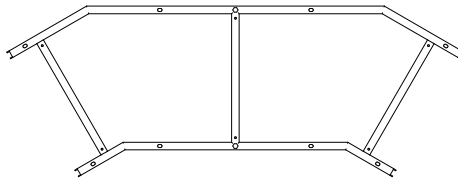

Doppelrundung (G)



Fuß (H)

Verfügbare Einheiten, Plätze/Platte

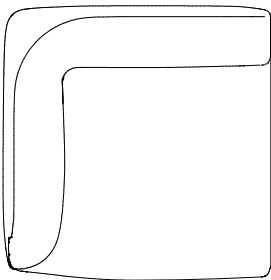

Einheit
Armlehne links
(L)

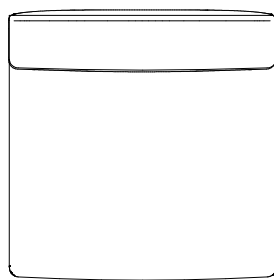

Einheit mit
Rückenlehne
(M)

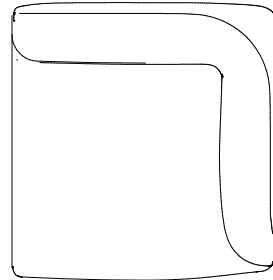

Einheit
Armlehne rechts
(N)

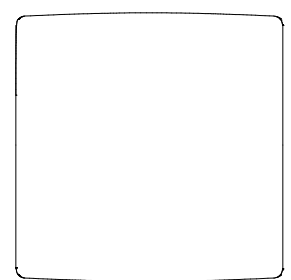

Pouf (P)

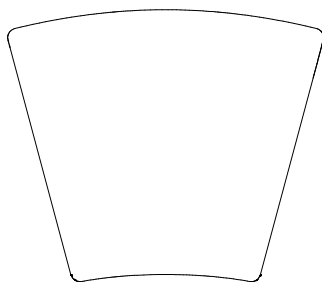

Einheit für
Rundung (Q)

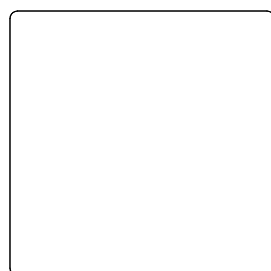

Tischchen (R)

Zusammenstellung Beispiele

Maßen in cm



Pouf
70 x 70 x Sh 42

- Seite (A) 2Stk.
- 1 Platz (C) 1Stk.
- Pouf (P) 1Stk.



Einheit mit Rückenlehne
70 x 70 x Sh 42

- Seite (A) 2Stk.
- 1 Platz (C) 1Stk.
- Einheit mit Rückenlehne (M) 1Stk.



Zwei-Sitzer mit Armlehnen
140 x 70 x Sh 42

- Seiten (A) 2Stk.
- 2 Plätze (D) 1Stk.
- Fuß (H) 2Stk.
- Einheit mit Lehne links (L) 1Stk.
- Einheit mit Lehne rechts (N) 1Stk.



Zwei-Sitzer mit Rückenlehne
140 x 70 x Sh 42

- Seite (A) 2Stk.
- 2 Plätze (D) 1Stk.
- Fuß (H) 2Stk.
- Einheit mit Rückenlehne (M) 2Stk.



Zwei-Sitzer, mit Rückenlehne und Pouf
140 x 70 x Sh 42

- Seite (A) 2Stk.
- 2 Plätze (D) 1Stk.
- Fuß (H) 2Stk.
- Einheit mit Rückenlehne (M) 1Stk.
- Pouf (P) 1Stk.

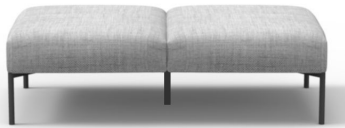

Zwei-Sitzer mit Pouf
140 x 70 x Sh 42

- Seite (A) 2Stk.
- 2 Plätze (D) 1Stk.
- Fuß (H) 2Stk.
- Pouf (P) 2Stk.



Zwei-Sitzer mit Armlehne und Pouf
140 x 70 x Sh 42

- Seite (A) 2Stk.
- 2 Plätze (D) 1Stk.
- Fuß (H) 2Stk.
- Einheit mit Armlehne links (L) 1Stk.
- Pouf (P) 1Stk.



Drei-Sitzer mit Armlehne und Rückenlehne
210 x 70 x Sh 42

- Seite (A) 2Stk.
- 3 Plätze (E) 1Stk.
- Fuß (H) 2Stk.
- Einheit mit Armlehne links(L) 1Stk.
- Einheit mit Rückenlehne (M) 1Stk.
- Einheit mit Lehne rechts (N) 1Stk.



- Seite (A) 2Stk.
- 3 Plätze (E) 1Stk.
- Fuß (H) 2Stk.
- Einheit mit Rückenlehne (M) 3Stk.

Drei-Sitzer mit Rückenlehnen
210 x 70 x Sh 42



- Seite (A) 2Stk.
- 3 Plätze (E) 1Stk.
- Fuß (H) 2Stk.
- Einheit mit Lehne links (L) 1Stk.
- Einheit mit Rückenlehne (M) 1Stk.
- Tischchen (R) 1Stk.

Drei-Sitzer mit Armlehne, Rückenlehne und
Tischchen
210 x 70 x Sh 42



- Seite (A) 2Stk.
- 3 Plätze (E) 1Stk.
- Fuß (H) 2Stk.
- Einheit mit Rückenlehne (M) 2Stk.
- Tischchen (R) 1Stk.

Drei-Sitzer mit Rückenlehne und Tischchen
210 x 70 x Sh 42



- Seite (A) 2Stk.
- 3 Plätze (E) 1Stk.
- Fuß (H) 2Stk.
- Einheit mit Rückenlehne (M) 1Stk.
- Pouf (P) 1Stk.
- Tischchen (R) 1Stk.

Drei-Sitzer mit Rückenlehne, Pouf und
Tischchen
210 x 70 x Sh 42



Drei-Sitzer mit Rückenlehne und Pouf
210 x 70 x Sh 42

- Seite (A) 2Stk.
- 3 Plätze (E) 1Stk.
- Fuß (H) 2Stk.
- Einheit mit Rückenlehne (M) 2Stk.
- Pouf (P) 1Stk.



Drei-Sitzer mit Rückenlehne und Pouf
210 x 70 x Sh 42

- Seite (A) 2Stk.
- 3 Plätze (E) 1Stk.
- Fuß (H) 2Stk.
- Einheit mit Rückenlehne (M) 1Stk.
- Pouf (P) 2Stk.



Drei-Sitzer mit Pouf
210 x 70 x Sh 42

- Seite (A) 2Stk.
- 3 Plätze (E) 1Stk.
- Fuß (H) 2Stk.
- Pouf (P) 3Stk.



- Seite (A) 2Stk.
- 2 Plätze (D) 1Stk.
- 3 Plätze (E) 2Stk.
- Doppelrundung (G) 1Stk.
- Einzelrundung (F) 1Stk.
- Verbindung (B) 4Stk.
- Fuß (H) 8Stk.
- Tischchen (R) 2Stk.
- Pouf (P) 3Stk.
- Einheit für Rundung(Q) 3Stk.
- Einheit mit Rückenlehne(M) 3Stk.

S-förmige Zusammenstellung
720 x 209 x Sh 42



- Verbindung (B) 6Stk.
- Doppelrundung(G) 6Stk.
- Fuß (H) 12Stk.
- Einheit für Rundung (Q) 12Stk.

Kreisförmige Zusammenstellung
D 325 x Sh 42

UMI CS/3405



Manuel d'utilisation

Copyright © Calligaris S.p.a. Tutti i diritti riservati - All right reserved



Calligaris S.p.a.
Via Trieste, 12
33044 Manzano
(Udine) Italy
Tel. +39 0432 748211
Fax +39 0432 750104

Bases: éléments disponibles

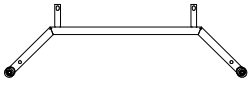

Côté (A)

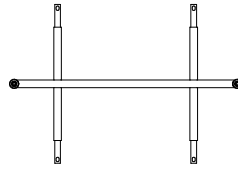

Connexion (B)

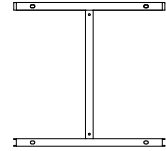

1 Place (C)

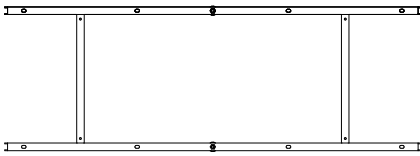

2 Places (D)

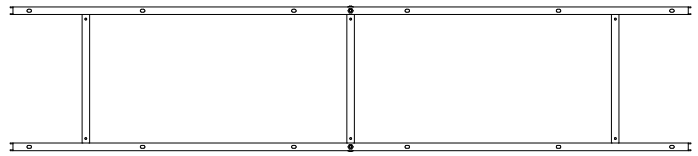

3 Places (E)

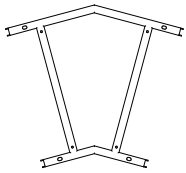

Courbe simple (F)

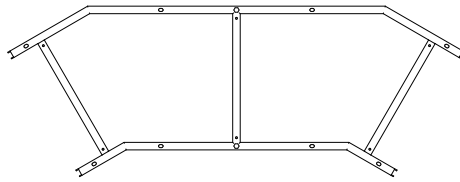

Courbe double (G)



Pied (H)

Assises/plateau: éléments disponibles

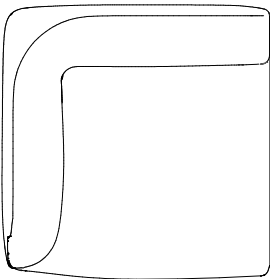

Assise avec
accoudoir
gauche (L)

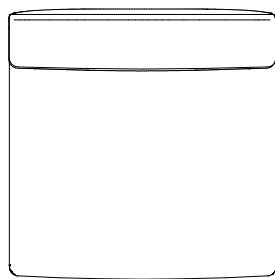

Assise avec
dossier (M)

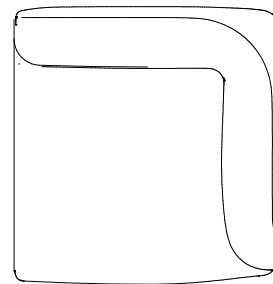

Assise avec
accoudoir droit
(N)

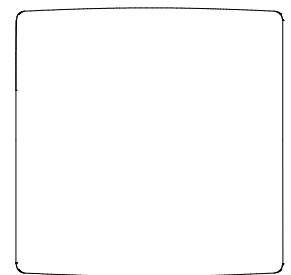

Pouf (P)

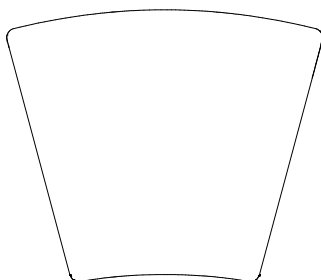

Assise pour
courbe (Q)

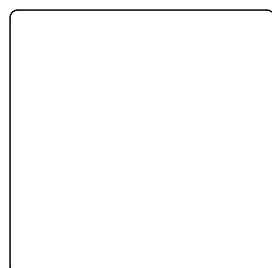

Table basse
(R)

Exemples de composition

mesures en cm



- Côté (A) 2pcs.
- 1 Place (C) 1pcs.
- Pouf (P) 1pcs.

Pouf
70 x 70 x Ha 42



- Côté (A) 2pcs.
- 1 Place (C) 1pcs.
- Assise avec dossier (M) 1pcs.

Assise avec dossier
70 x 70 x Ha 42



- Côté (A) 2pcs.
- 2 Places(D) 1pcs.
- Pied (H) 2pcs.
- Assise avec accoudoir gauche (L) 1pcs.
- Assise avec accoudoir droit (N) 1pcs.

Deux places avec accoudoirs
140 x 70 x Ha 42



- Côté (A) 2pcs.
- 2 Places (D) 1pcs.
- Pied (H) 2pcs.
- Assise avec dossier (M) 2pcs.

Deux places avec dossier
140 x 70 x Ha 42



Deux places avec dossier et pouf
140 x 70 x Ha 42

- Côté (A) 2pcs.
- 2 Places (D) 1pcs.
- Pied (H) 2pcs.
- Assise avec dossier (M) 1pcs.
- Pouf (P) 1pcs.



Deux places avec pouf
140 x 70 x Ha 42

- Côté (A) 2pcs.
- 2 Places (D) 1pcs.
- Pied (H) 2pcs.
- Pouf (P) 2pcs.



Deux places avec accoudoir et pouf
140 x 70 x Ha 42

- Côté (A) 2pcs.
- 2 Places (D) 1pcs.
- Pied (H) 2pcs.
- Assise avec accoudoir gauche (L) 1pcs.
- Pouf (P) 1pcs.



Trois places avec accoudoir et avec dossier
210 x 70 x Ha 42

- Côté (A) 2pcs.
- 3 Places (E) 1pcs.
- Pied (H) 2pcs.
- Assise avec accoudoir gauche (L) 1pcs.
- Assise avec dossier (M) 1pcs.
- Assise avec accoudoir droit (N) 1pcs.



Trois places avec dossiers
210 x 70 x Ha 42

- Côté (A) 2pcs.
- 3 Places (E) 1pcs.
- Pied (H) 2pcs.
- Assise avec dossier (M) 3pcs.



Trois places avec accoudoir, avec dossier et
table basse
210 x 70 x Ha 42

- Côté (A) 2pcs.
- 3 Places (E) 1pcs.
- Pied (H) 2pcs.
- Assise avec accoudoir gauche (L) 1pcs.
- Assise avec dossier (M) 1pcs.
- Table basse (R) 1pcs.



Trois places avec dossier et table basse
210 x 70 x Ha 42

- Côté (A) 2pcs.
- 3 Places (E) 1pcs.
- Pied (H) 2pcs.
- Assise avec dossier (M) 2pcs.
- Table basse (R) 1pcs.



Trois places avec dossier, avec pouf et table
basse
210 x 70 x Ha 42

- Côté (A) 2pcs.
- 3 Places (E) 1pcs.
- Pied (H) 2pcs.
- Assise avec dossier (M) 1pcs.
- Pouf (P) 1pcs.
- Table basse (R) 1pcs.



Trois places avec dossier et pouf
210 x 70 x Ha 42

- Côté (A) 2pcs.
- 3 Places (E) 1pcs.
- Pied (H) 2pcs.
- Assise avec dossier (M)2pcs.
- Pouf (P) 1pcs.



Trois places avec dossier et pouf
210 x 70 x Ha 42

- Côté (A) 2pcs.
- 3 Places (E) 1pcs.
- Pied (H) 2pcs.
- Assise avec dossier (M)1pcs.
- Pouf (P) 2pcs.



Trois places avec pouf
210 x 70 x Ha 42

- Côté (A) 2pcs.
- 3 Places (E) 1pcs.
- Pied (H) 2pcs.
- Pouf (P) 3pcs.



- Côté (A) 2pcs.
- 2 Places (D) 1pcs.
- 3 Places (E) 2pcs.
- Courbe double (G) 1pcs.
- Courbe unique (F) 1pcs.
- Connexion (B) 4pcs.
- Pied (H) 8pcs.
- Table basse (R) 2pcs.
- Pouf (P) 3pcs.
- Assise pour courbe (Q) 3pcs.
- Assise avec dossier (M) 3pcs.

Composition à "S"
720 x 209 x Ha 42



- Connexion (B) 6pcs.
- Courbe double (G) 6pcs.
- Pied (H) 12pcs.
- Assise pour courbe (Q) 12pcs.

Composition circulaire
D 325 x Ha 42

UMI CS/3405

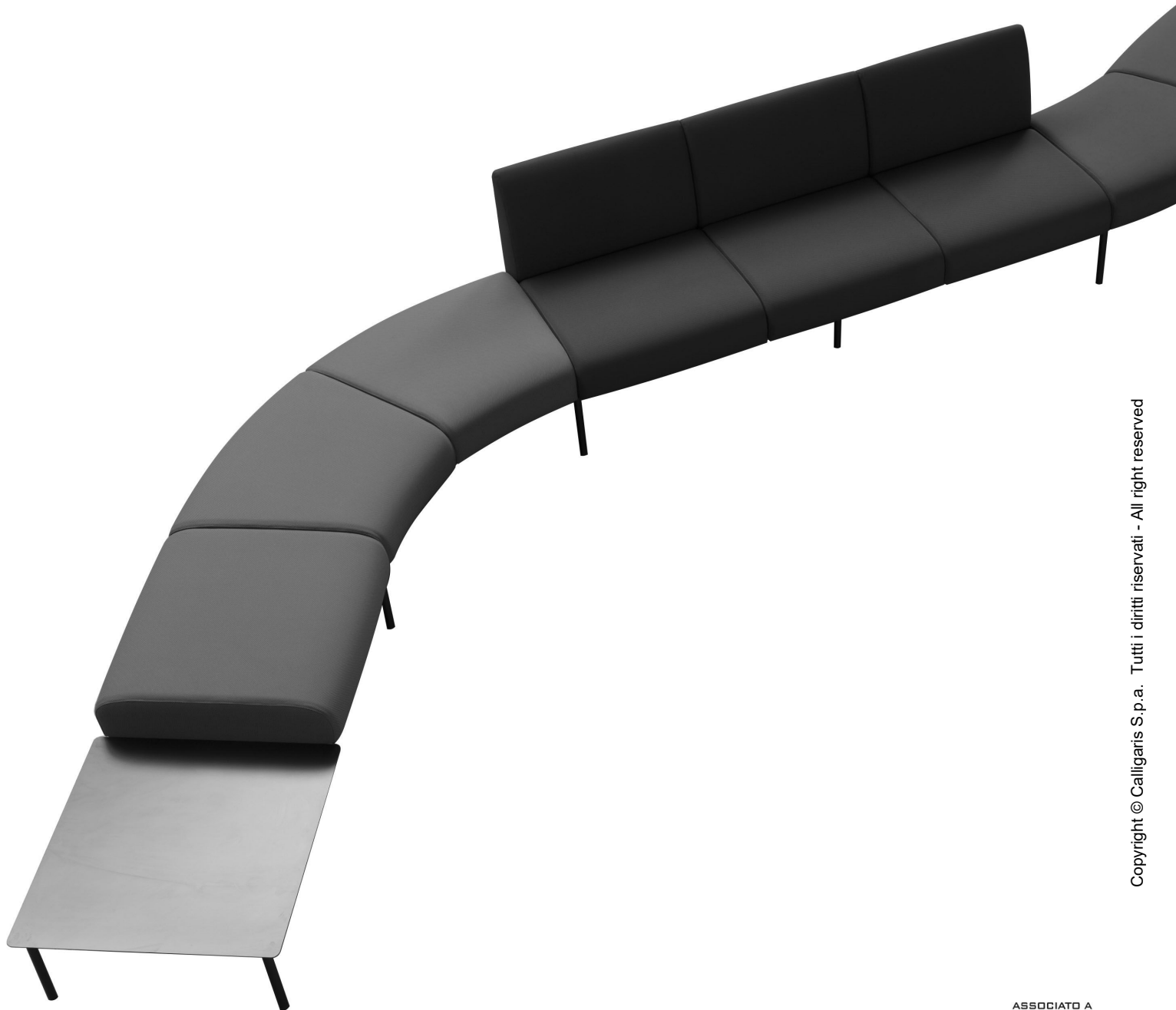

Manual de
instrucciones

Copyright © Calligaris S.p.a. Tutti i diritti riservati - All right reserved



Calligaris S.p.a.
Via Trieste, 12
33044 Manzano
(Udine) Italy
Tel. +39 0432 748211
Fax +39 0432 750104

Elementos disponibles base



Lado (A)

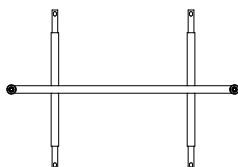

Conexión (B)

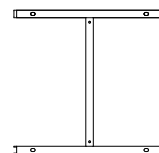

1 Asiento (C)

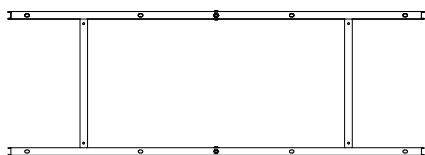

2 Asientos (D)

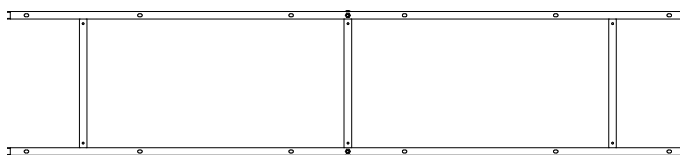

3 Asientos (E)

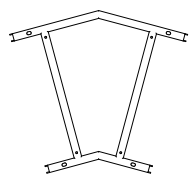

Curva Individual (F)

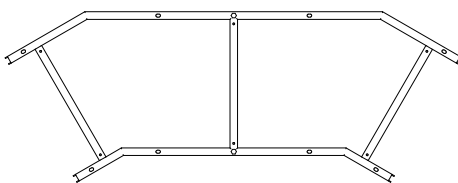

Curva Doble (G)



Pie (H)

Elementos disponibles asientos/tapa

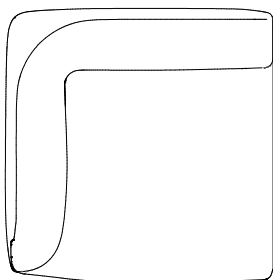

Asiento Reposabrazos IZQ (L)

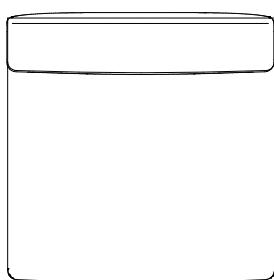

Asiento con Respaldo (M)

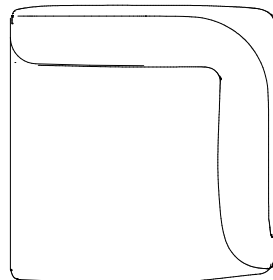

Asiento Reposabrazos DCHA (N)

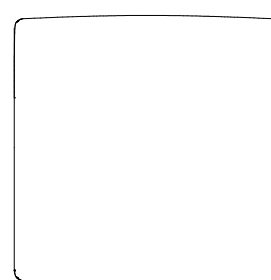

Pouf (P)

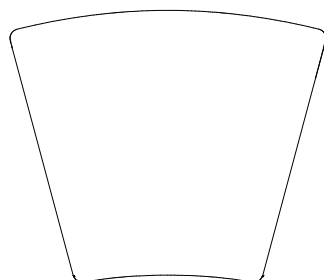

Asiento para Curva (Q)

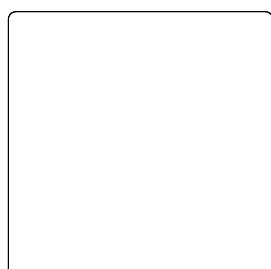

Mesita (R)

Ejemplos de composición

medidas en cm



Pouf
70 x 70 x Ha 42

- Lado (A) 2pza.
- 1 Asiento (C) 1pza.
- Pouf (P) 1pza.



Asiento con Respaldo
70 x 70 x Ha 42

- Lado (A) 2pza.
- 1 Asiento (C) 1pza.
- Asiento con Respaldo (M) 1pza.



Dos Asientos con Reposabrazos
140 x 70 x Ha 42

- Lado (A) 2pza.
- 2 Asientos (D) 1pza.
- Pie (H) 2pza.
- Asiento Reposabrazos IZQ (L) 1pza.
- Asiento Reposabrazos DCHA (N) 1pza.



Dos Asientos con Respaldo
140 x 70 x Ha 42

- Lado (A) 2pza.
- 2 Asientos (D) 1pza.
- Pie (H) 2pza.
- Asiento con Respaldo (M) 2pza.



- Lado (A) 2pza.
- 2 Asientos (D) 1pza.
- Pie (H) 2pza.
- Asiento con Respaldo (M) 1pza.
- Pouf (P) 1pza.

Asiento con Respaldo y pouf
140 x 70 x Ha 42



- Lado (A) 2pza.
- 2 Asientos (D) 1pza.
- Pie (H) 2pza.
- Pouf (P) 2pza.

Dos Asientos con pouf
140 x 70 x Ha 42



- Lado (A) 2pza.
- 2 Asientos (D) 1pza.
- Pie (H) 2pza.
- Asiento Reposabrazos IZQ (L) 1pza.
- Pouf (P) 1pza.

Dos Asientos con Reposabrazos y pouf
140 x 70 x Ha 42



- Lado (A) 2pza.
- 3 Asientos (E) 1pza.
- Pie (H) 2pza.
- Asiento Reposabrazos IZQ (L) 1pza.
- Asiento con Respaldo (M) 1pza.
- Asiento Reposabrazos DCHA (N) 1pza.

Tres Asientos con Reposabrazos y con Respaldo
210 x 70 x Ha 42



Tre Asientos con Respaldos
210 x 70 x Ha 42

- Lado (A) 2pza.
- 3 Asientos (E) 1pza.
- Pie (H) 2pza.
- Asiento con Respaldo (M) 3pza.



Tres Asientos con Reposabrazos, con
Respaldos y mesita
210 x 70 x Ha 42

- Lado (A) 2pza.
- 3 Asientos (E) 1pza.
- Pie (H) 2pza.
- Asiento Reposabrazos IZQ (L) 1pza.
- Asiento con Respaldo (M) 1pza.
- Mesita (R) 1pza.



Tre Asientos con Respaldos y mesita
210 x 70 x Ha 42

- Lado (A) 2pza.
- 3 Asientos (E) 1pza.
- Pie (H) 2pza.
- Asiento con Respaldo (M) 2pza.
- Mesita (R) 1pza.



Tre Asientos con Respaldos, con pouf y
mesita
210 x 70 x Ha 42

- Lado (A) 2pza.
- 3 Asientos (E) 1pza.
- Pie (H) 2pza.
- Asiento con Respaldo (M) 1pza.
- Pouf (P) 1pza.
- Mesita (R) 1pza.



Tre Asientos con Respaldos y pouf
210 x 70 x Ha 42

- Lado (A) 2pza.
- 3 Asientos (E) 1pza.
- Pie (H) 2pza.
- Asiento con Respaldo (M) 2pza.
- Pouf (P) 1pza.



Tre Asientos con Respaldos y pouf
210 x 70 x Ha 42

- Lado (A) 2pza.
- 3 Asientos (E) 1pza.
- Pie (H) 2pza.
- Asiento con Respaldo (M) 1pza.
- Pouf (P) 2pza.

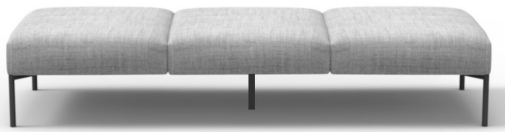

Tre Asientos con pouf
210 x 70 x Ha 42

- Lado (A) 2pza.
- 3 Asientos (E) 1pza.
- Pie (H) 2pza.
- Pouf (P) 3pza.









- Lado (A) 2pza.
- 2 Asientos (D) 1pza.
- 3 Asientos (E) 2pza.
- Curva Doble (G) 1pza.
- Curva Individual (F) 1pza.
- Conexión (B) 4pza.
- Pie (H) 8pza.
- Mesita (R) 2pza.
- Pouf (P) 3pza.
- Asiento para curva (Q) 3pza.
- Asiento con Respaldo (M) 3pza.

Composición a "S"
720 x 209 x Ha 42

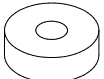
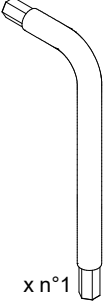

- Conexión (B) 6pza.
- Curva Doble (G) 6pza.
- Pie (H) 12pza.
- Asiento para curva (Q) 12pza.

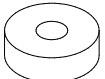
Composición circular
D 325 x Ha 42

 F-3405A  a x n°4  b x n°4  x n°1	 F-3405  b x n°2	<ul style="list-style-type: none"> - I Prima di iniziare il montaggio, identificare tutti i componenti con l'aiuto delle istruzioni. - GB Before starting to assembling, please identify all components. - D Vor der Montage, sind die Einzelteile anhand der Montageanleitung zu identifizieren. - F Avant de débiter le montage, identifiez tous les composants a l'aide de la notice. - E Antes de iniciar el montaje, identifique todos los components con ayuda de la nota.
 F-3405B  c	<ul style="list-style-type: none"> - I Solo per D / E / G. - GB Only for D / E / G. - D Nur für D / E / G. - F Uniquement pour D / E / G. - E Solo para D / E / G. 	



- **I** Pezzo di ricambio.
- **GB** Spare part.
- **D** Ersatzteil.
- **F** Pièce en échange / s.a.v.
- **E** Repuesto

Attenzione-Attention-Vorsicht-Attention-Atención

- **I** Si consiglia di effettuare il montaggio su una superficie morbida.
- **GB** It is recommended to use a soft protective cloth during assembling.
- **D** Möbelteile auf eine weiche Oberfläche legen und dann aufstellen.
- **F** Veuillez poser les pièces sur un surface souple pour l'assemblage.
- **E** Se aconseja efectuar el montaje sobre una superficie blanda.

1A

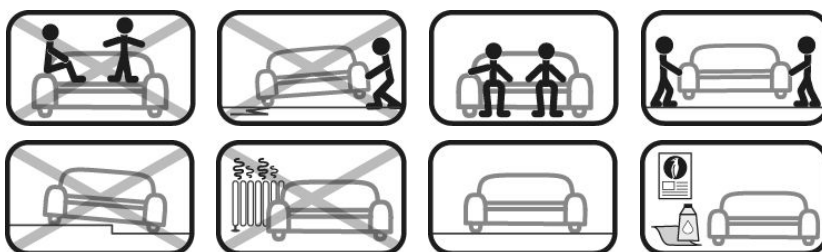
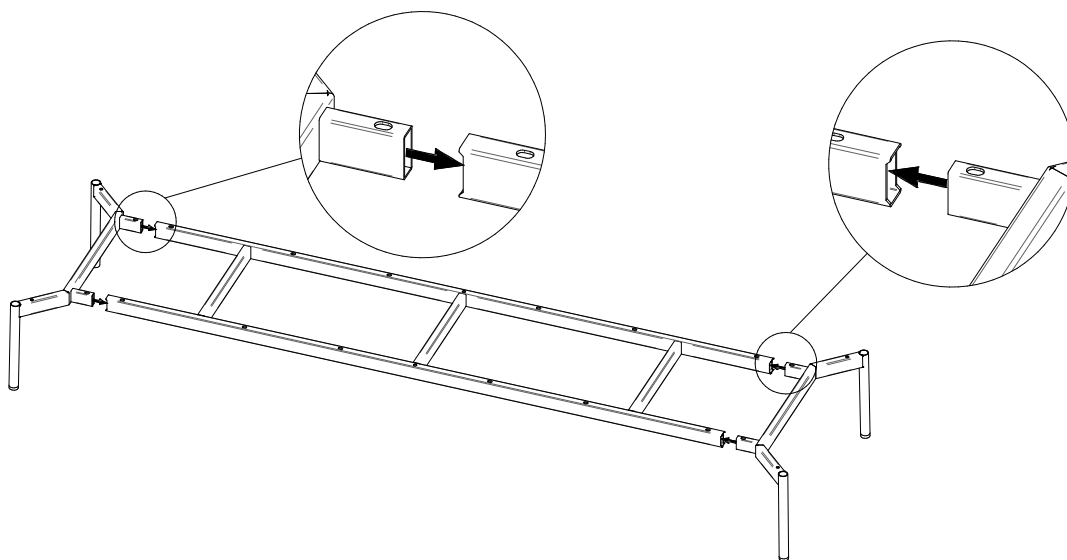

1B

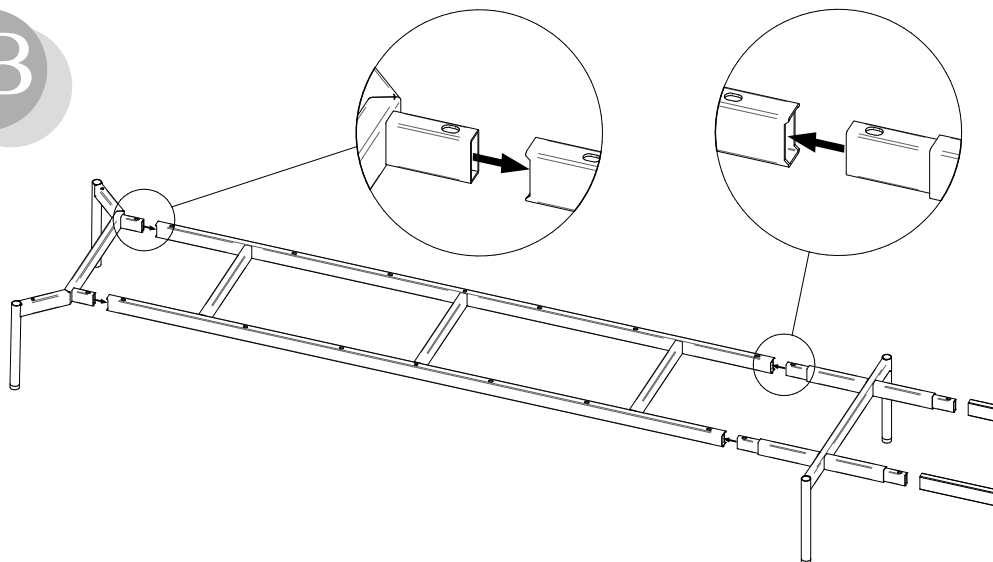

2

2a

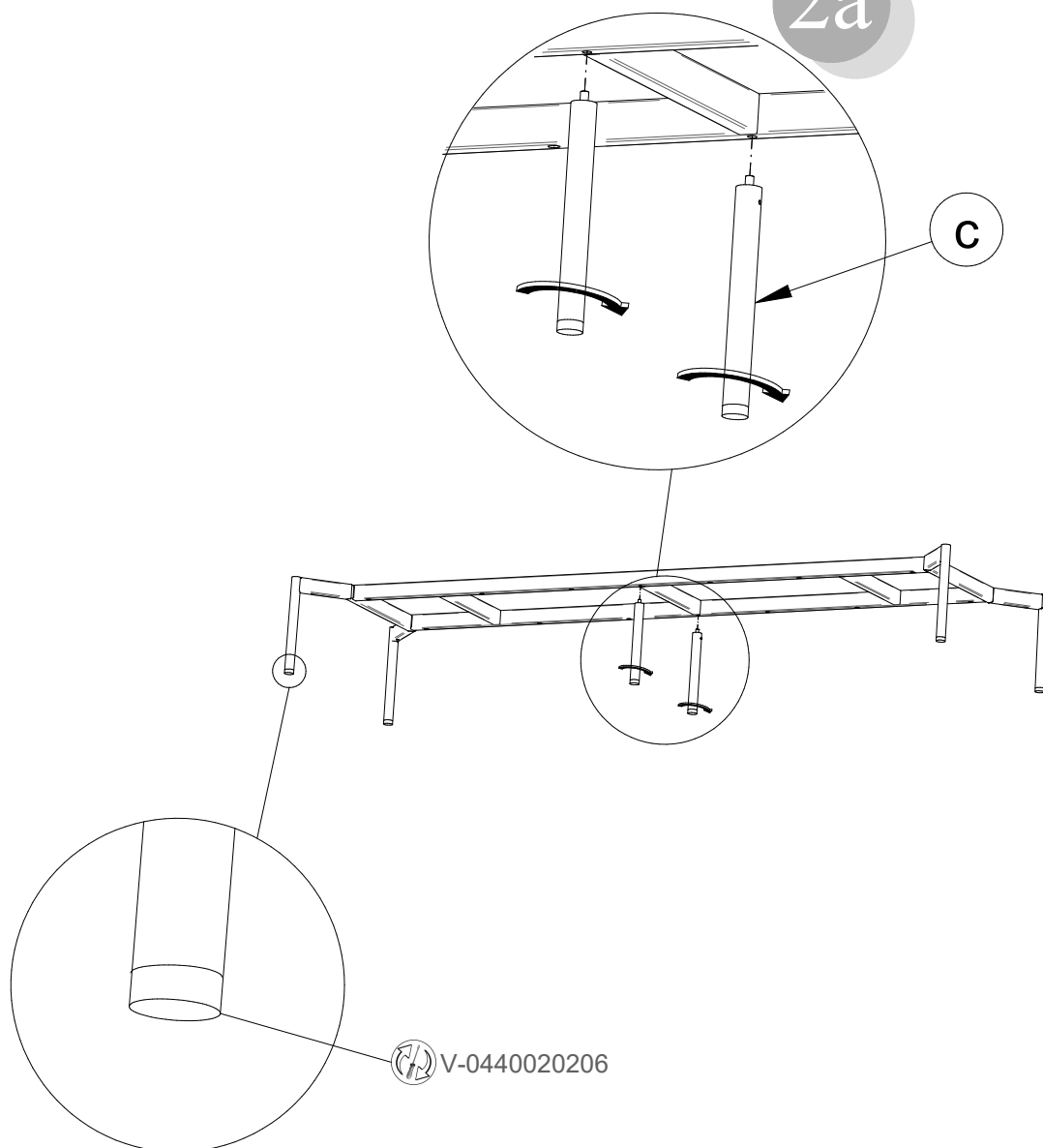

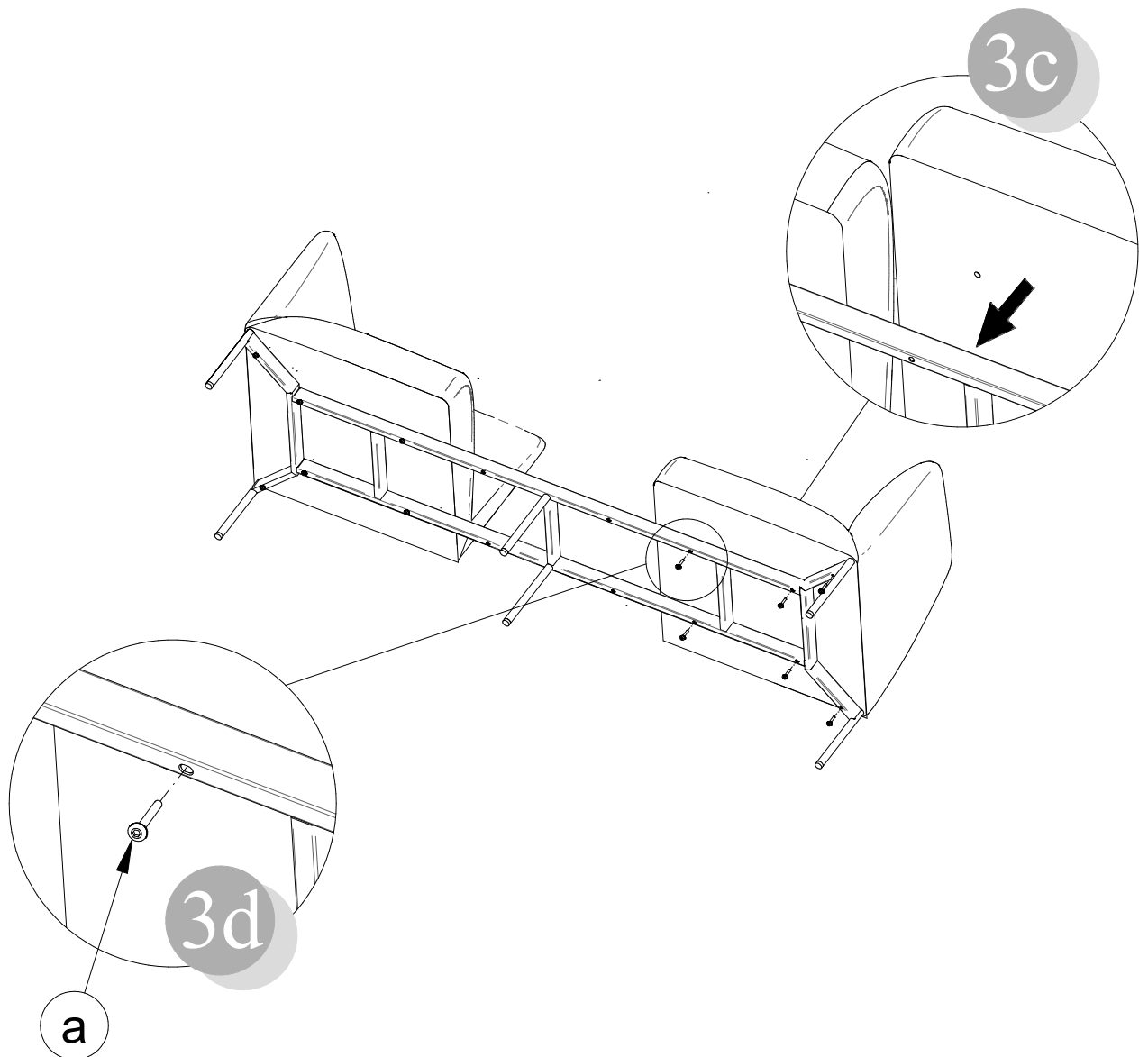
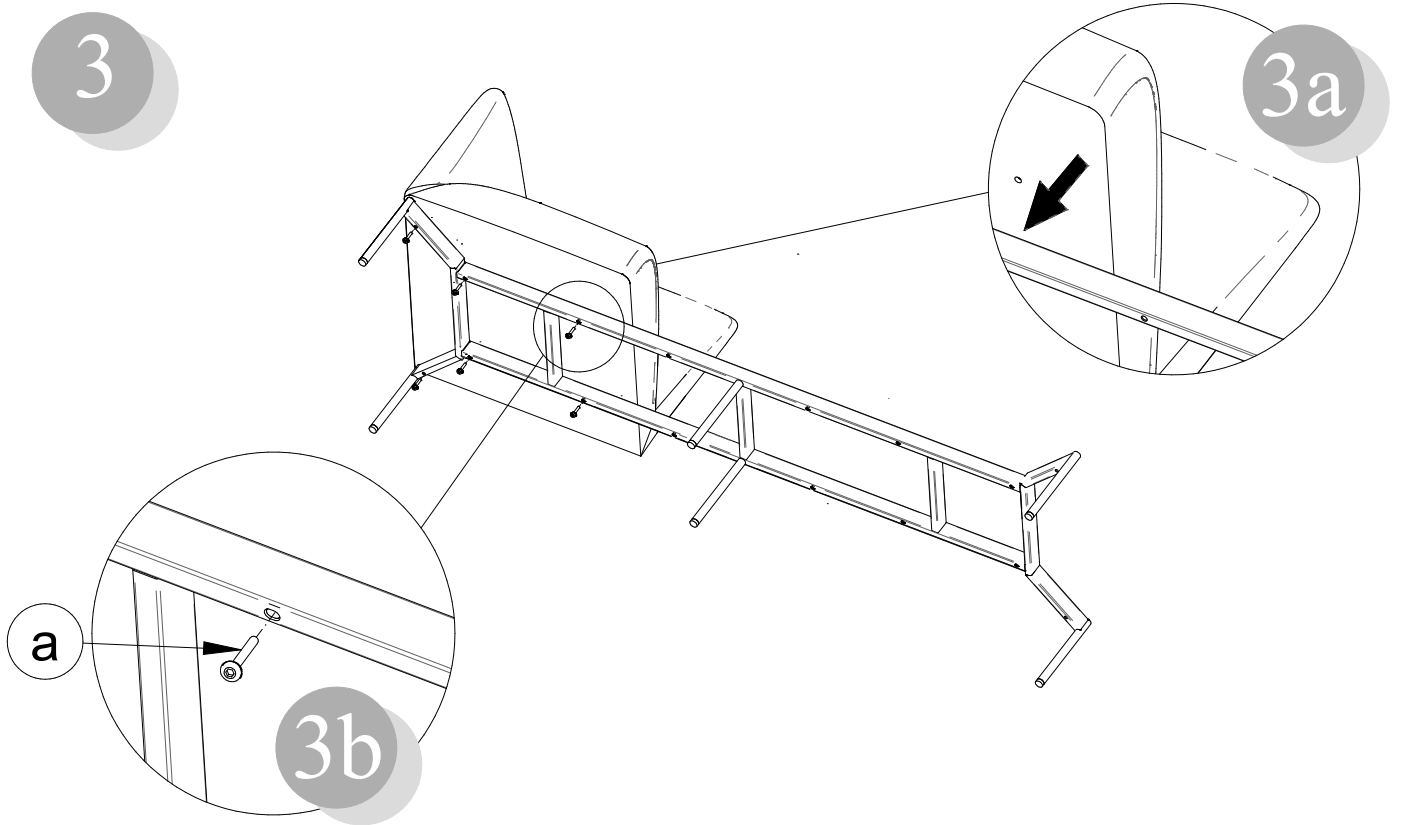

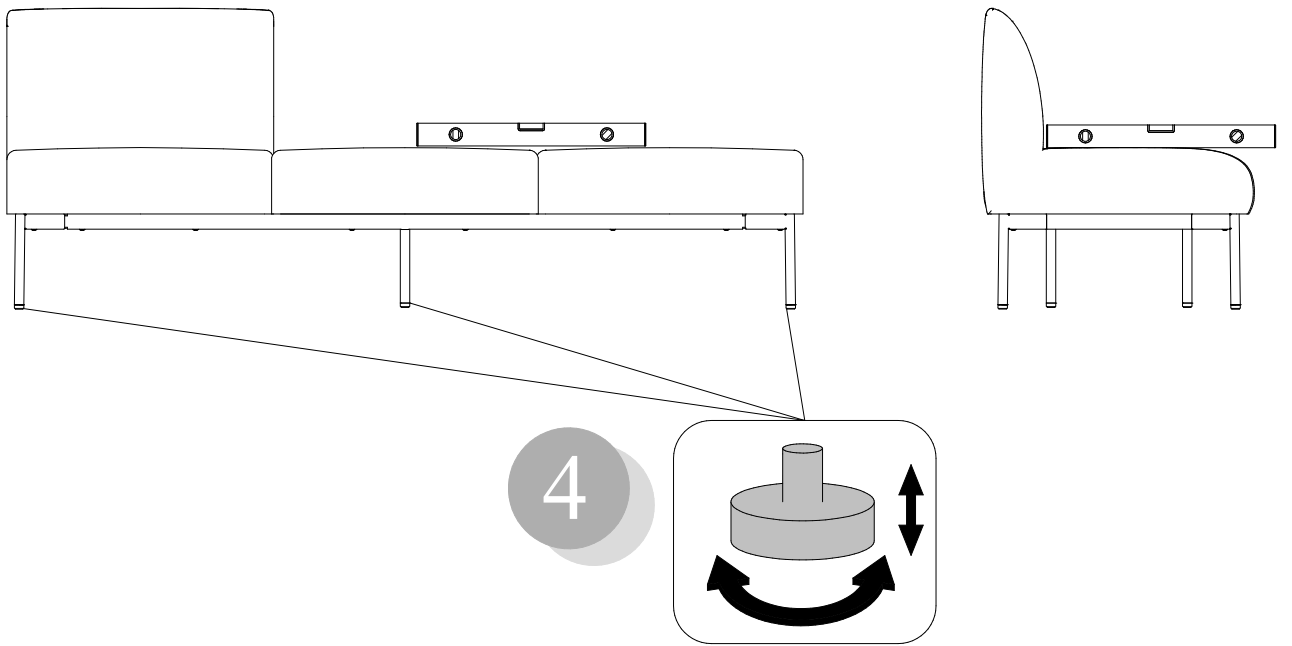
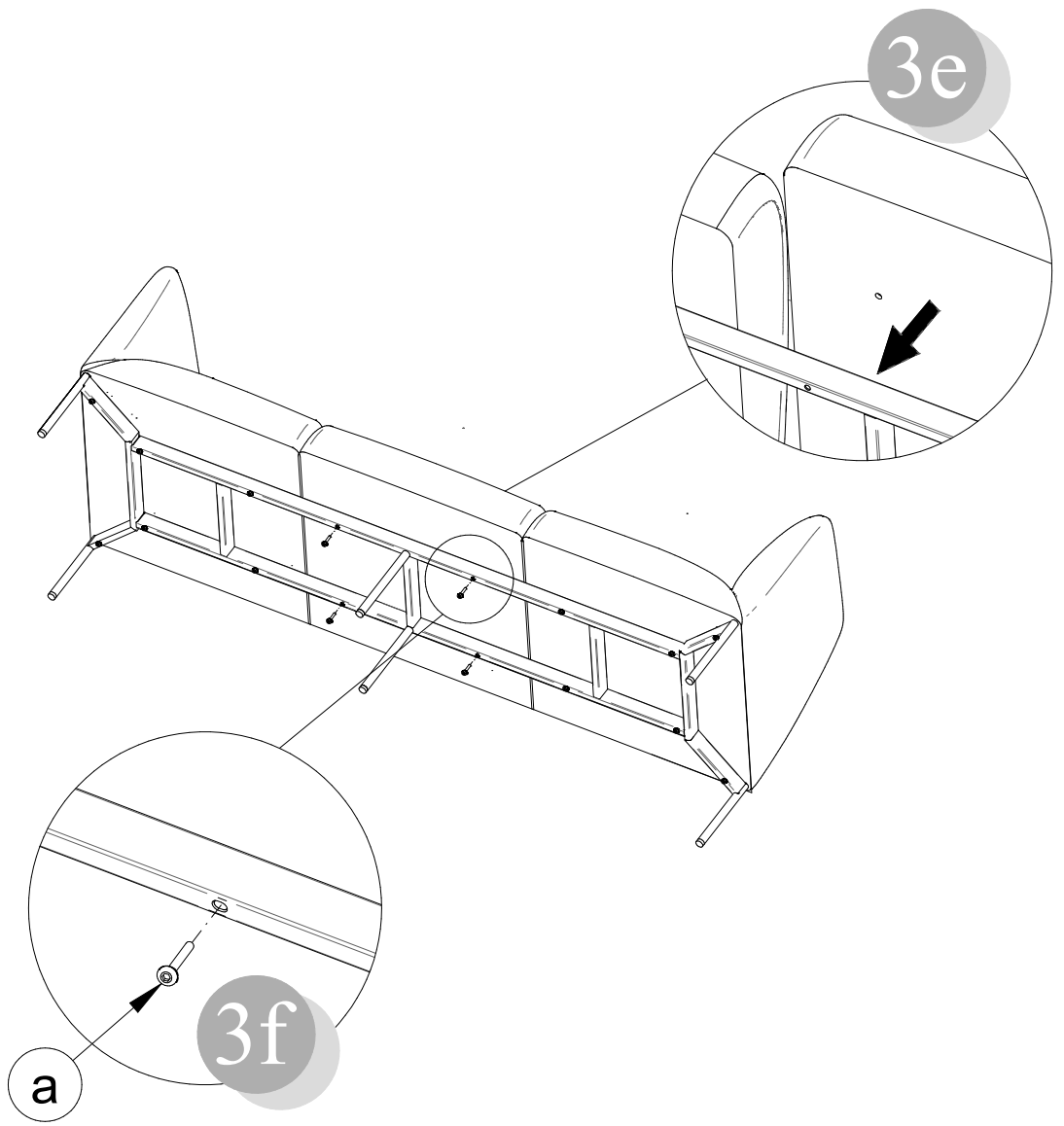

5

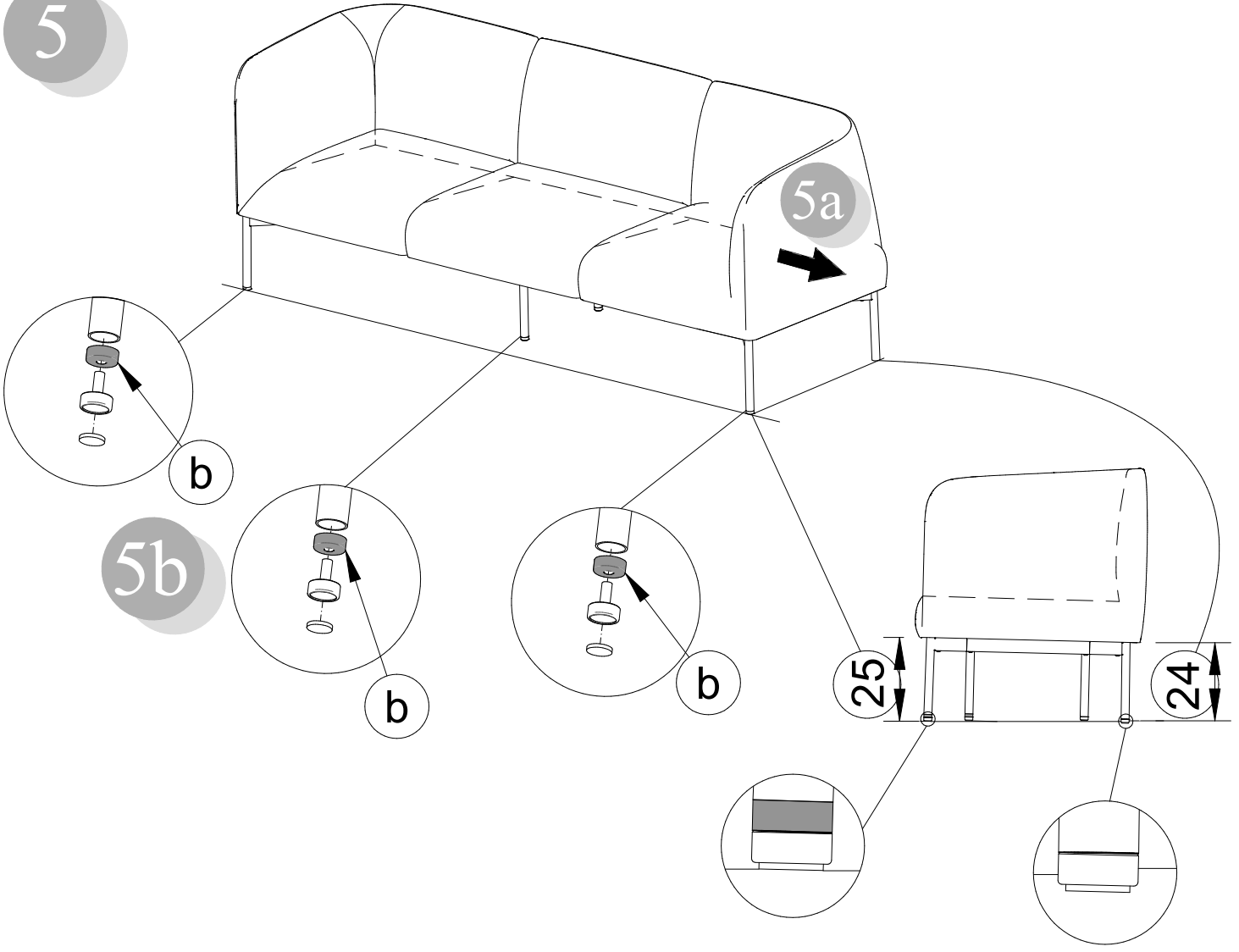

Per fissaggio tavolino - Table assembly - Zur Tischbefestigung - Pour la fixation de la table - Para la mesa de fijación

